

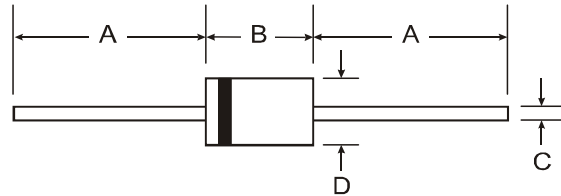

Features

- Diffused Junction
- Fast Switching for High Efficiency
- High Current Capability and Low Forward Voltage Drop
- Surge Overload Rating to 30A Peak
- Low Reverse Leakage Current
- **Lead Free Finish, RoHS compliant (Note 4)**



Mechanical Data

- Case: DO-41, A-405
- Case Material: Molded Plastic. UL Flammability Classification Rating 94V-0
- Moisture Sensitivity: Level 1 per J-STD-020D
- Terminals: Finish - Tin. Plated Leads Solderable per MIL-STD-202, Method 208 
- Polarity: Cathode Band
- Marking: Type Number
- Ordering Information: See Page 3
- DO-41 Weight: 0.35 grams (approximate)
- A-405 Weight: 0.2 grams (approximate)

Dim	DO-41 Plastic		A-405	
	Min	Max	Min	Max
A	25.40	—	25.40	—
B	4.06	5.21	4.10	5.20
C	0.71	0.864	0.53	0.64
D	2.00	2.72	2.00	2.70
All Dimensions in mm				

“L” Suffix Designates A-405 Package
No Suffix Designates DO-41 Package

Maximum Ratings and Electrical Characteristics

@T_A = 25°C unless otherwise specified

Single phase, half wave, 60Hz, resistive or inductive load.
For capacitive load, derate current by 20%.

Characteristic	Symbol	PR 1001/L	PR 1002/L	PR 1003/L	PR 1004/L	PR 1005/L	Unit	
Peak Repetitive Reverse Voltage	V _{RRM}							
Working Peak Reverse Voltage	V _{RWM}	50	100	200	400	600	V	
DC Blocking Voltage (Note 5)	V _R							
RMS Reverse Voltage	V _{R(RMS)}	35	70	140	280	420	V	
Average Rectified Output Current (Note 1)	I _O	1.0						A
		@ T _A = 75°C						
Non-Repetitive Peak Forward Surge Current 8.3ms Single Half Sine-Wave Superimposed on Rated Load	I _{FSM}	30						A
Forward Voltage Drop	V _{FM}	1.2						V
		@ I _F = 1.0A						
Peak Reverse Current at Rated DC Blocking Voltage (Note 5)	I _{RM}	5.0						μA
		@ T _A = 25°C						
		@ T _A = 100°C						
Reverse Recovery Time (Note 3)	t _{rr}	150				250		ns
Typical Total Capacitance (Note 2)	C _T	15				8.0		pF
Typical Thermal Resistance Junction to Ambient	R _{θJA}	75						°C/W
Operating and Storage Temperature Range	T _J , T _{STG}	-65 to +150						°C

- Notes:
1. Valid provided that leads are maintained at ambient temperature at a distance of 9.5mm from the case.
 2. Measured at 1.0MHz and applied reverse voltage of 4.0V DC.
 3. Measured with I_F = 0.5A, I_R = 1A, I_{rr} = 0.25A. See figure 5.
 4. RoHS revision 13.2.2003. High temperature solder exemption applied, see *EU Directive Annex Note 7*.
 5. Short duration pulse test used to minimize self-heating effect.

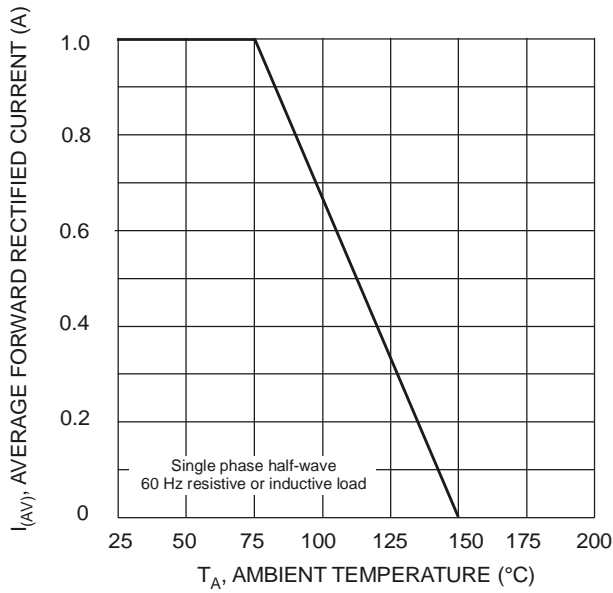

Fig. 1 Forward Derating Curve

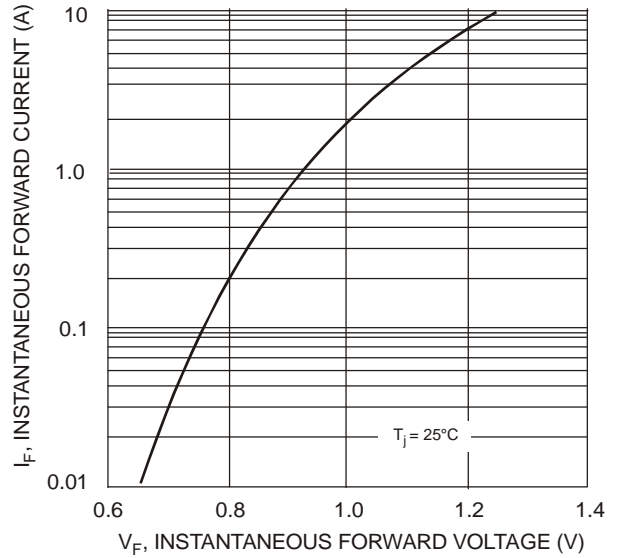

Fig. 2 Typical Forward Characteristics

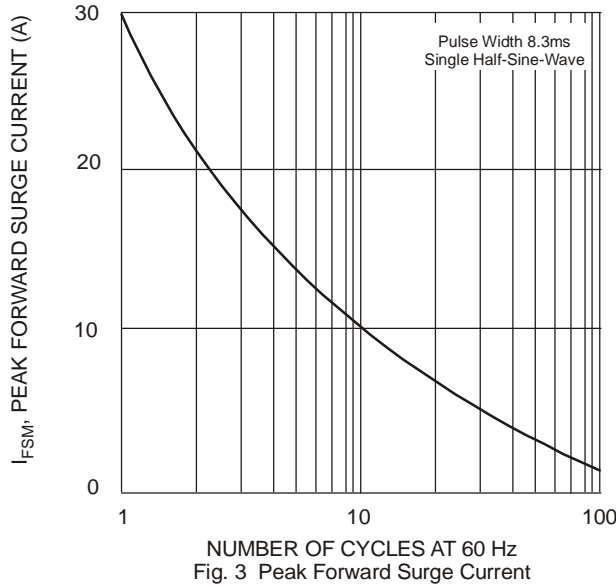

Fig. 3 Peak Forward Surge Current

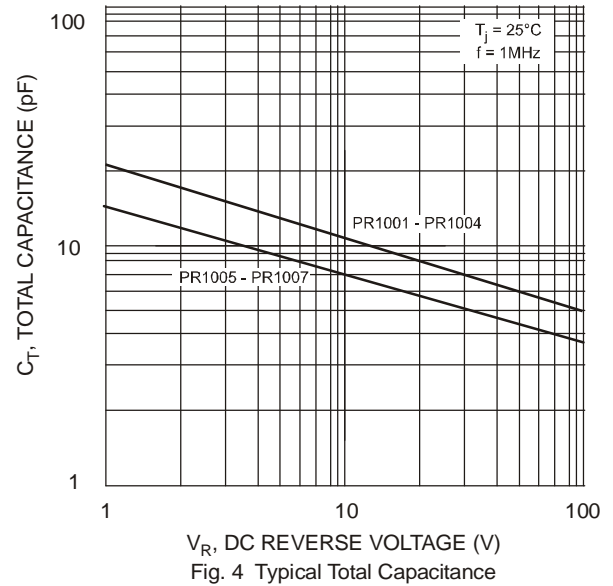
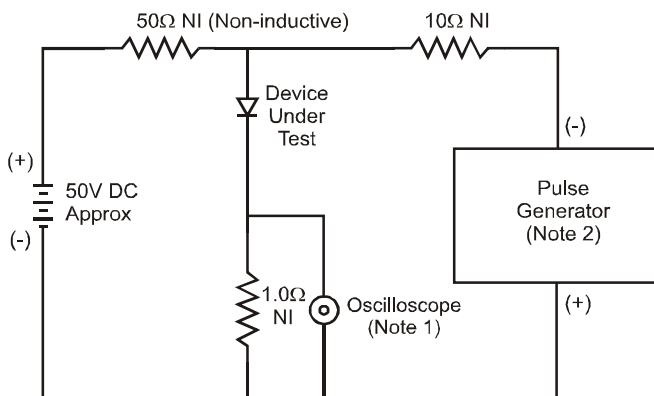

Fig. 4 Typical Total Capacitance



- Notes:
1. Rise Time = 7.0ns max. Input Impedance = 1.0MW, 22pF.
 2. Rise Time = 10ns max. Input Impedance = 50W.

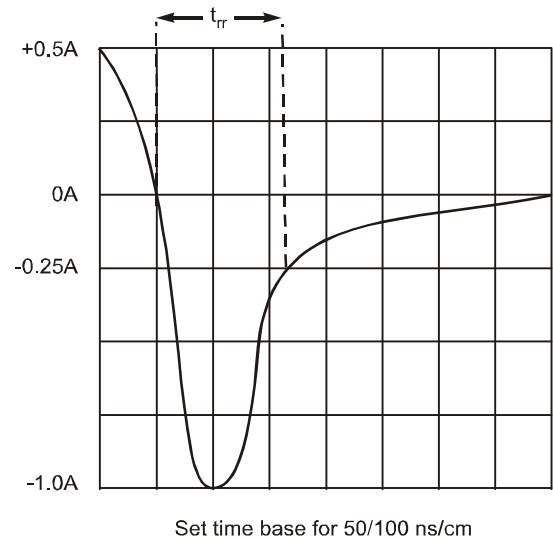

Fig. 5 Reverse Recovery Time Characteristic and Test Circuit

Ordering Information (Note 6)

Device	Packaging	Shipping
PR1001-A	DO-41	5K/Ammo Pack
PR1001-B	DO-41	1K/Bulk
PR1001-T	DO-41	5K/Tape & Reel, 13-inch
PR1002-A	DO-41	5K/Ammo Pack
PR1002-B	DO-41	1K/Bulk
PR1002-T	DO-41	5K/Tape & Reel, 13-inch
PR1003-A	DO-41	5K/Ammo Pack
PR1003-B	DO-41	1K/Bulk
PR1003-T	DO-41	5K/Tape & Reel, 13-inch
PR1004-A	DO-41	5K/Ammo Pack
PR1004-B	DO-41	1K/Bulk
PR1004-T	DO-41	5K/Tape & Reel, 13-inch
PR1005-A	DO-41	5K/Ammo Pack
PR1005-B	DO-41	1K/Bulk
PR1005-T	DO-41	5K/Tape & Reel, 13-inch
PR1001L-T	A-405	5K/Tape & Reel, 13-inch
PR1002L-T	A-405	5K/Tape & Reel, 13-inch
PR1003L-T	A-405	5K/Tape & Reel, 13-inch
PR1004L-T	A-405	5K/Tape & Reel, 13-inch
PR1005L-T	A-405	5K/Tape & Reel, 13-inch

Notes: 6. For packaging details, visit our website at <http://www.diodes.com/datasheets/ap02008.pdf>.

IMPORTANT NOTICE

Diodes Incorporated and its subsidiaries reserve the right to make modifications, enhancements, improvements, corrections or other changes without further notice to any product herein. Diodes Incorporated does not assume any liability arising out of the application or use of any product described herein; neither does it convey any license under its patent rights, nor the rights of others. The user of products in such applications shall assume all risks of such use and will agree to hold Diodes Incorporated and all the companies whose products are represented on our website, harmless against all damages.

LIFE SUPPORT

Diodes Incorporated products are not authorized for use as critical components in life support devices or systems without the expressed written approval of the President of Diodes Incorporated.